

NACHI

Compact Variable Pump Unit

NSP Series

Energy saving
type friendly
to the earth



Powerful
&
Compact

*Energy saving unit
friendly to the earth*

NSP Series

Machine tool power source

- Compact, lightweight and economical plus
"energy savings of approximately 40 percent
as compared to the standard unit"

(Comparison made in our company when pressure is held)

NSP Series is an earth-friendly hydraulic unit characterized by further improvement in energy saving efficiency of the conventional NACHICCO.

Energy saving design
with unrivalled
equipment efficiency

● Improved energy saving effect

Energy saving of approximately 40 percent as compared to the standard unit has been achieved by further improvement in energy saving efficiency of the conventional NACHICCO.

(Comparison made in our company when pressure is held)

● Compact size

Installation space is minimized by use of a variable vane pump built integrally with the motor combined with efficient layout.

● Easy handling and maintenance

Simple structure and excellent reliability ensure easy handling and maintenance.

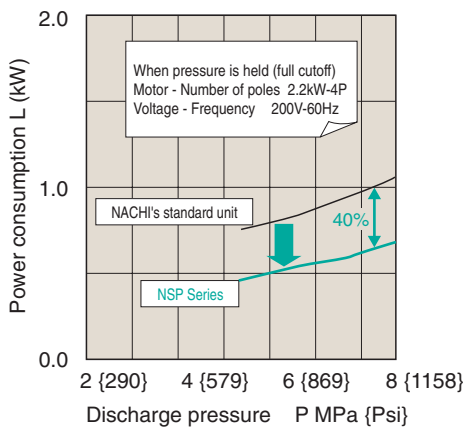

● Lower heat generation at higher efficiency

The pump and motor is characterized by high efficiency low heat generation especially when pressure is held, thereby supporting high precision of the basic machine.

● Resource-saving efficiency

Only a small amount of oil in the tank is required. This feature makes a significant contribution to saving resources on the earth.

Specifications

Item	Type	NSP-※-※VOA※	NSP-※-※V1A※
Pump capacity	cm ³ /rev	8.0	16.0
Maximum pressure	MPa	8.0 {1,158 psi} (full cutoff pressure)	
Motor output	kW	0.75, 1.5	1.5, 2.2
Tank capacity	ℓ	10, 20	
Installation space	mm	300×400 (11.81×15.75 inch)	
Approximate weight	kg	43 (94.8 lbs) (10 ℓ, 1.5kW, without option)	



Description of symbols

NSP-10-07 V 0A2- F2T -13

- Notes: 1. There is a restriction to the combination, for example, between pump capacity and motor capacity. For details, see the description in the column of Precautions or Selection.
2. The design number may be subject to change without prior notice due to the change in our policy.

Design number
Option (in alphabetical order) F※R※: Block mounted (Details are given below)
T: Oil level gauge with thermometer

Pressure adjusting range (A: fixed delivery type)
A2 : 217~579psi (507psi) A3 : 507~869psi (724psi)
A4 : 796~1158psi (1014psi)

Note 1. The numeral in parenthesis indicates a full cutoff set value at the time of shipment from the factory.

Flow rate control range (maximum capacity) 0 : 8 cm³/rev 1 : 16cm³/rev

Note 2. Indicates the above-mentioned maximum value at the time of shipment from the factory.

Pump: variable vane pump

Motor capacity : 07 : 0.75kW 15 : 1.5kW 22 : 2.2kW

Tank capacity: 10 and 20 liters (an optional 30-liter type is also available)

Compact hydraulic unit NSP Series

External view/dimensional table

NSP-※-※※V ※A※-13

mm (inch)

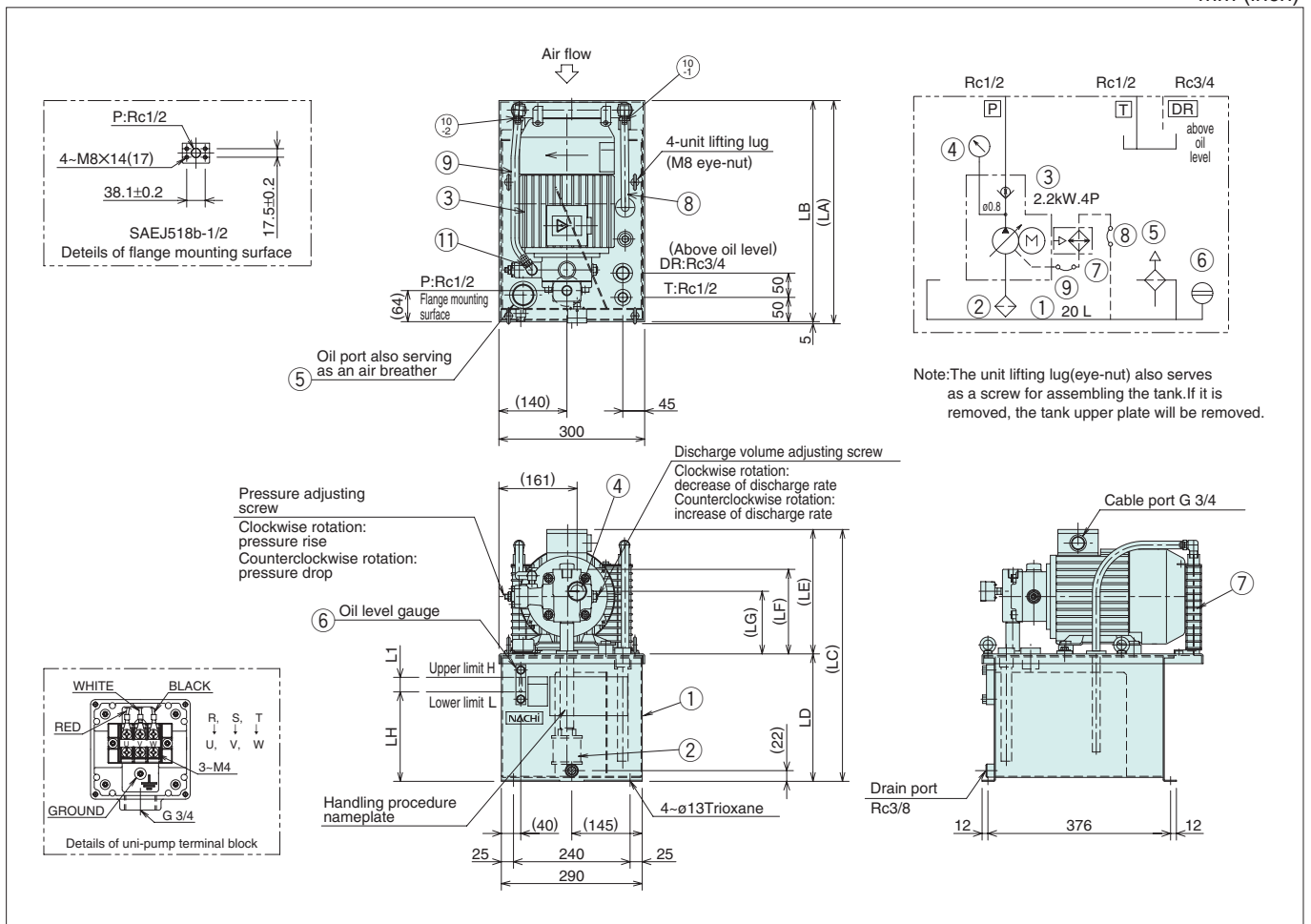

Type	Motor (kW-P)	Dimensions mm (inch)											Approximate weight kg (lbs)	
		LA	LB	LC	LD	LE	LF	LG	LH	LI	H	L		
NSP-10-07V※A※-※-13	0.75-4	405 (15.94)	400 (15.75)	400 (15.75)		240 (9.45)	154 (6.06)	109 (4.29)						36 (79.4)
NSP-10-15V※A※-※-13	1.5 -4	430 (16.93)	425 (16.73)	402 (15.83)	160 (6.30)	242 (9.53)	164 (6.46)	119 (4.69)	102 (4.29)	10 (0.39)	10L (0.39)	9L (0.35)		42 (92.6)
NSP-10-22V※A※-※-13	2.2 -4	460 (18.11)	455 (17.91)	422 (16.61)		262 (10.31)	174 (6.85)	129 (5.08)						48 (106.0)
NSP-20-07V※A※-※-13	0.75-4	405 (15.94)	400 (15.75)	502 (19.76)		240 (9.45)	154 (6.06)	109 (4.29)						39 (86.0)
NSP-20-15V※A※-※-13	1.5 -4	430 (16.93)	425 (16.73)	504 (19.84)	262 (10.31)	242 (9.53)	164 (6.46)	119 (4.69)	185 (7.28)	30 (1.18)	20L (0.79)	17L (0.67)		45 (99.2)
NSP-20-22V※A※-※-13	2.2 -4	460 (18.11)	455 (17.91)	524 (20.63)		262 (10.31)	174 (6.85)	129 (5.08)						51 (112.0)

(Without hydraulic oil)

Motor selection method

The available range in the rated output of each motor is shown below the output curve of each motor in the graph.

(Example)

Find the motor to be used at a pressure of 3.5MPa (507psi), discharge rate of 12 liters/min. and frequency of 60Hz.

(Solution)

As illustrated by the broken line in the graph, you are looking for the motor located above the crossing point between the pressure of 3.5MPa (507psi) and discharge rate of 12 liters/min.

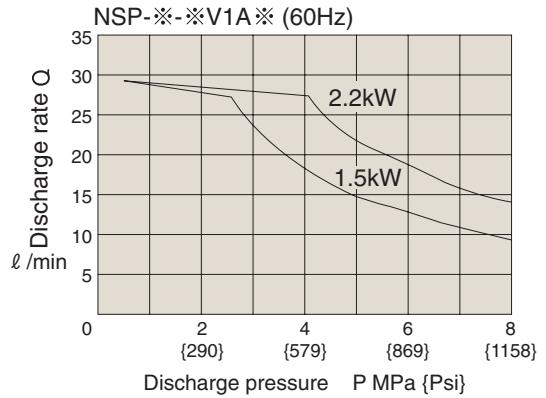
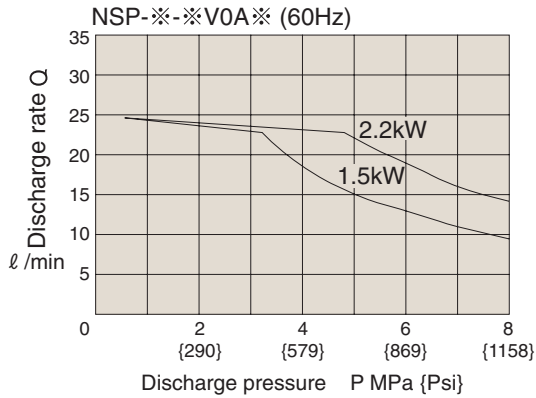
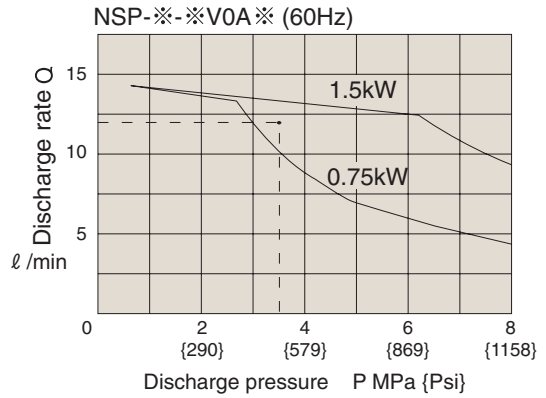
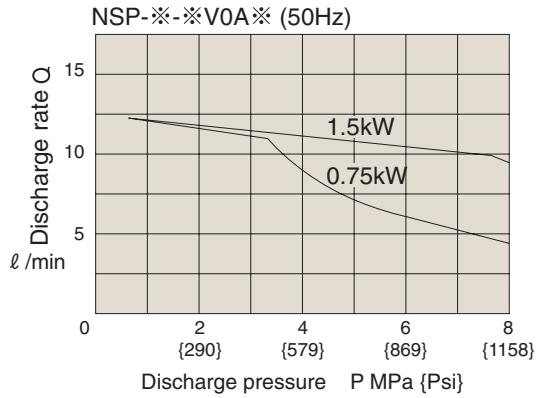

[Additional example of block]

NSP-10-07V0 A2-F2-13

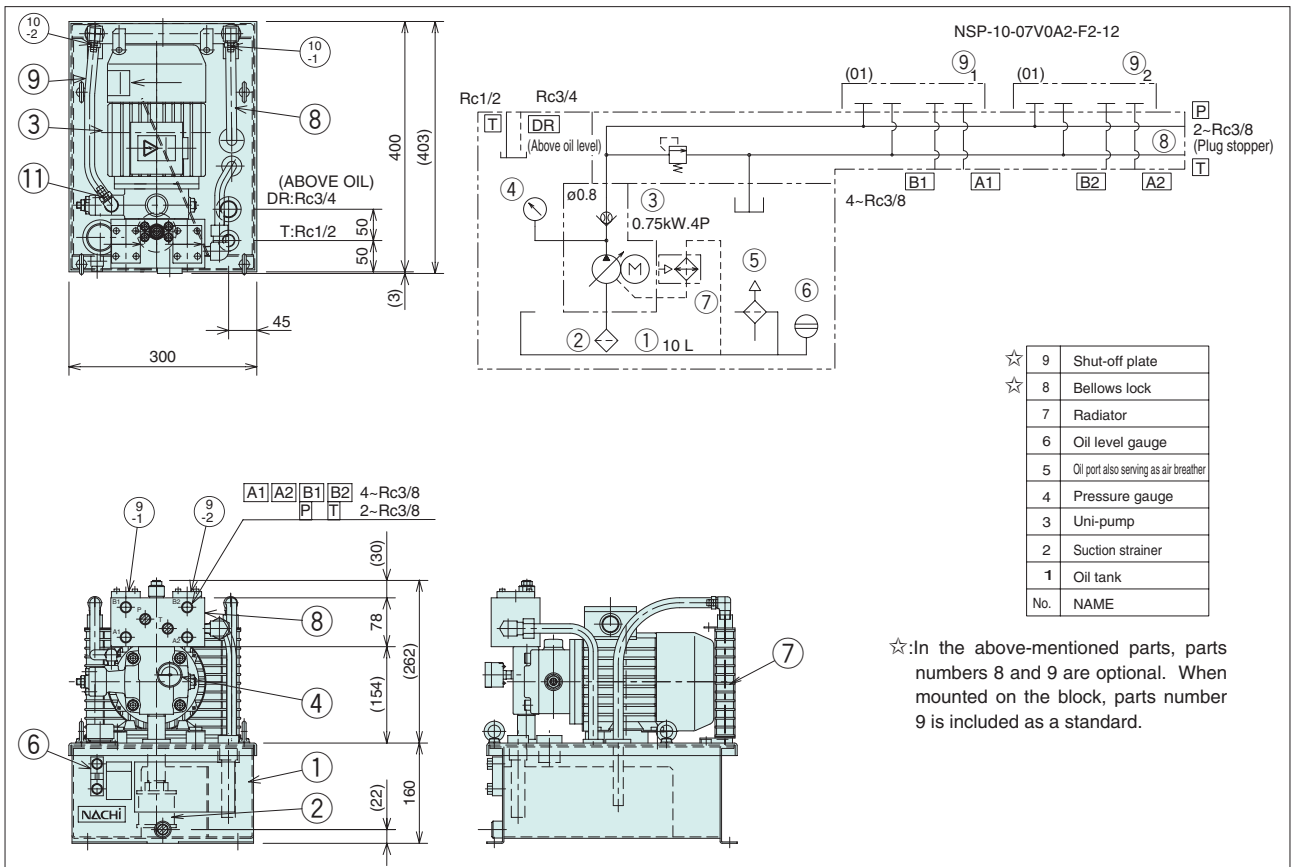

Performance Characteristics

① Power consumption

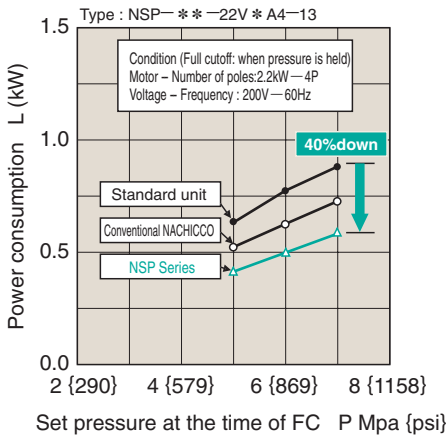

② Noise characteristics

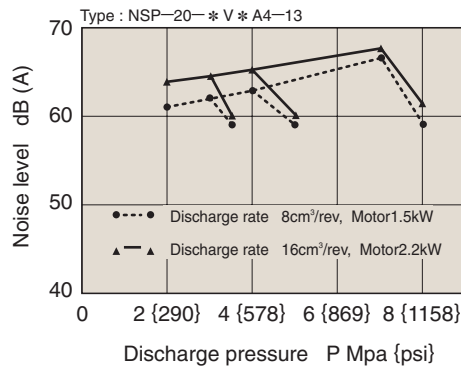

Conditions

(The value in the left-hand drawing represents typical characteristics under the following conditions).

Oil used:

ISO VG32 or its equivalent

Oil temperature: 40±5°C

Speed: 1800min⁻¹

Measuring distance:

1 meter around the unit

Note: The noise characteristics depend on the installation floor, base conditions and the presence or absence of the surrounding substance reflecting the sound, and so may be different from the above description in some cases.

③ Oil temperature characteristics

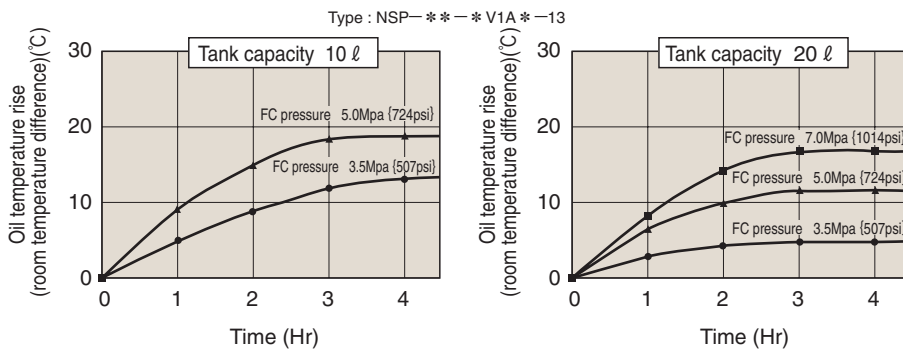

Conditions

(The value on the left-hand drawing represents typical characteristics under the following conditions).

Oil used:

ISO VG32 or its equivalent

Speed: 1800min⁻¹

Room temperature: 29°C

Motor: 0.75~2.2kW

Notes:

- For 5.0 MPa {724 psi} of a 1.10-liter tank, it should be noted that there is a big rise in oil temperature under continuous operation. In this case, we recommend use of a 20-liter tank.
- Rise of oil temperature depends on the conditions of using an actual machine, and so may be different from the above description in some cases.

Precautions for selection

● Type combination

① The right-hand table shows the standard combination between pumps and motors.

Pump	Motor kW	0.75	1.5	2.2
0A※		○	○	
1A※			○	○

② A tank capacity of 30 liters is optional.

③ The block mounting type is provided with a shut-off plate.

● Circuit configuration

① The basic configuration comprises a NACHICCO (NSP-※※) as a standard product plus external manifold (circuit).

② Piping should be arranged with a sufficient deflection between the NACHICCO and external manifold.

- We recommend use of a hose having a normal pressure of 14 MPa {2027 psi} and a length of about 1 through 2 meters (40~80 inch).
- The maximum peak pressure (set pressure + surge pressure) should not exceed 14 MPa {2027 psi}.
- When the pressure rises above 14 MPa {2027 psi}, install a relief valve for surge cutting on the circuit side.

● Mounted manifold block

① When a manifold block (optional) is mounted on the pump, the total weight of the block and valve should not exceed 15 kg (33.07 lbs).

Type of block	F1·R1	F2·R2	F3	
Weight of block	kg (lbs)	4.5 (9.92)	6.5 (14.33)	8.5 (18.74)
Allowance for additional mounting	kg (lbs)	10.5 (23.15)	8.5 (18.74)	6.5 (14.33)

② When you want to install the circuit, consult our company.

● Specifications for painting

- The inner and outer sides of the tank and motor portion are provided with melamine resin baking, and the pump portion is provided with lacquer blowing. Their color conforms to Fujikoshi standard color (Munsell NO.5B^{6/3}).
- For the color of exterior features, consult our company.

Details of options

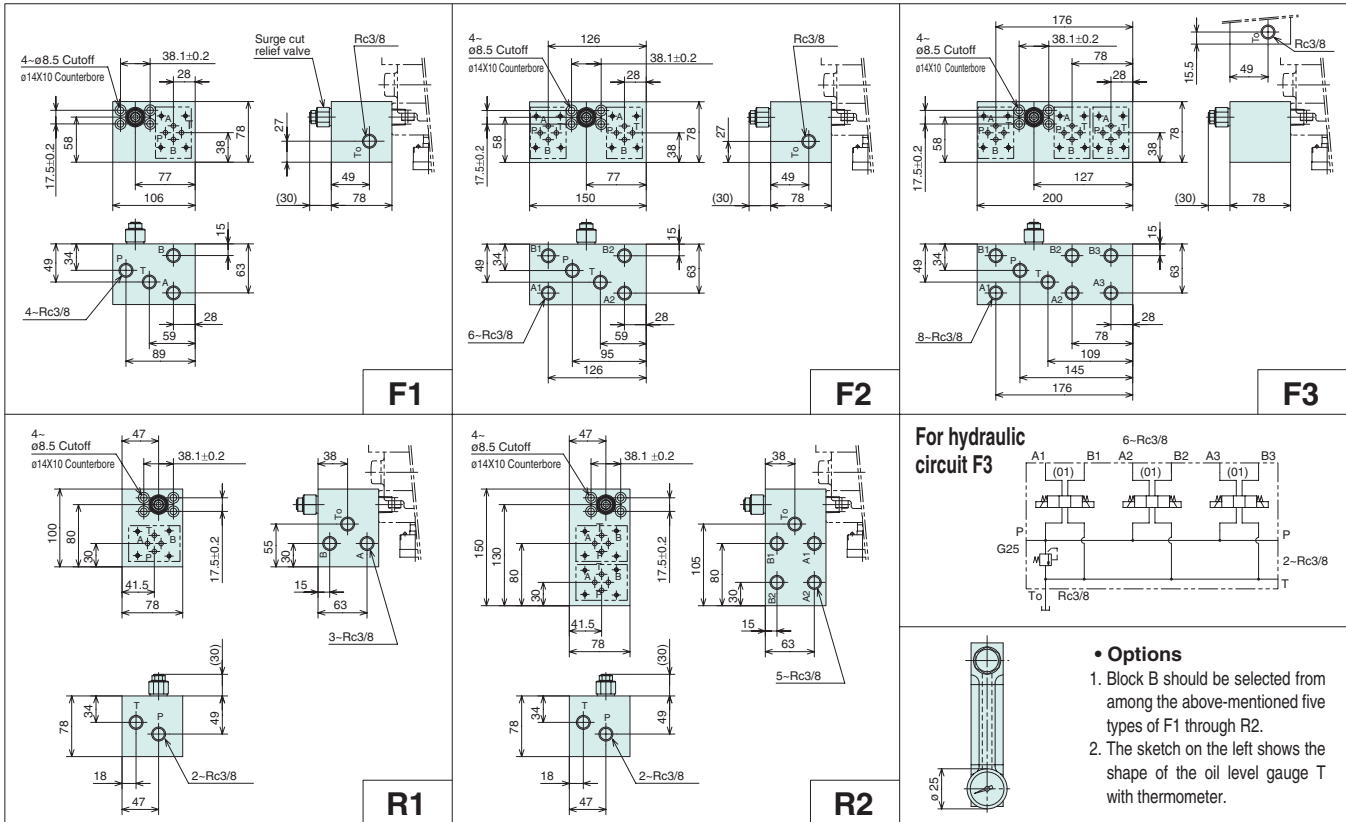

Note: Adjustment of the surge cut relief valve is strictly prohibited.

Handling procedure

●Precautions in startup

- Check if the tank is filled with hydraulic oil up to the specified level.
 - [A] Upper limit, Yellow mark: specified oil level (nominal capacity)
 - [B] Lower limit, Red mark: minimum oil level
 Hydraulic oil: Based on general mineral oil, ISO VG32 or its equivalent
- Electric connection should be made correctly according to the following procedure:

Phases of motor side and power supply side

U → R
V → S
W → T

If electric connection is incorrect:

- The motor pump rotates in the reverse direction without discharging oil. If the operation is continued, the pump may be damaged.
- Use the pressure gauge mounted on the discharge side and make sure that pressure rises.

- Repeat the procedure of starting and stopping the motor. Remove air from inside the pump and suction pipe. (You can remove air more quickly if you remove loads from the circuit.)

●Pressure and discharge rate adjustment procedure

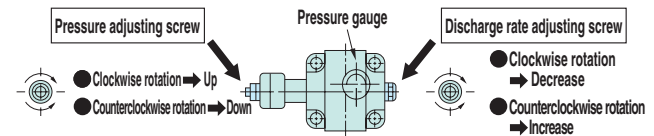

Note: Do not touch any screw except for the above-mentioned adjusting screw.

●Maintenance and inspection

- Oil temperature: Use it at the temperature from 10 to 60 °C.
- Hydraulic oil replacement interval: Replace hydraulic oil three months after the start of operation in the beginning. Then replace it whenever contamination has been observed or after the lapse of one year.
- Inspection and cleaning of tank interior and strainer: every 6 months or every 4000 hours (whichever comes first)

●Ambient temperature

- Temperature: 10 to 35 °C
- Do not use the mist of water soluble coolant.

NACHI

NACHI-FUJIKOSHI CORP. (TOKYO HEAD OFFICE)

Shiodome Sumitomo Bldg., 1-9-2 Higashi-shinbashi, Minato-ku, Tokyo 105-0021
Tel:+81-(0)3-5568-5240 Fax:+81-(0)3-5568-5236 URL:<http://www.nachi-fujikoshi.co.jp>

NACHI AMERICA INC.

715 Pushville Road, Greenwood, Indiana, 46143, U.S.A.
Tel:+1-317-530-1001 Fax:+1-317-530-1011 URL:<http://www.nachi-america.com/>

**NACHI-FUJIKOSHI CORP.
THAILAND REPRESENTATIVE OFFICE**

Unit 23/109(A), Fl. 24th Sorachai Bldg., 23 Sukhumvit 63 Road (Ekamai),
Klongtonnua, Wattana, Bangkok 10110, THAILAND
Tel:+66-2-714-0008 Fax:+66-2-714-0740

NACHI SINGAPORE PTE. LTD.

No.2 Joo Koon Way, Jurong Town, Singapore 628943, SINGAPORE
Tel:+65-65587393 Fax:+65-65587371

NACHI EUROPE GmbH

Bischofstrasse 99, 47809, Krefeld, GERMANY
Tel:+49-(0)2151-65046-0 Fax:+49-(0)2151-65046-90 URL:<http://www.nachi.de/>

U.K. BRANCH

Unit 7, Junction Six Industrial Estate, Electric Avenue, Birmingham B6 7JJ, U.K.
Tel:+44-(0)121-250-1880 Fax:+44-(0)121-250-1889

CATALOG NO.

H1062E-3

2010.12.Y-SE-SE